



**Office of the Federal Antimonopoly Service
in the Perm region (Perm OFAS Russia)**

Competition in the low-competitive market

Conditions of the market of central heat supply of the Perm city

Distribution of market share*

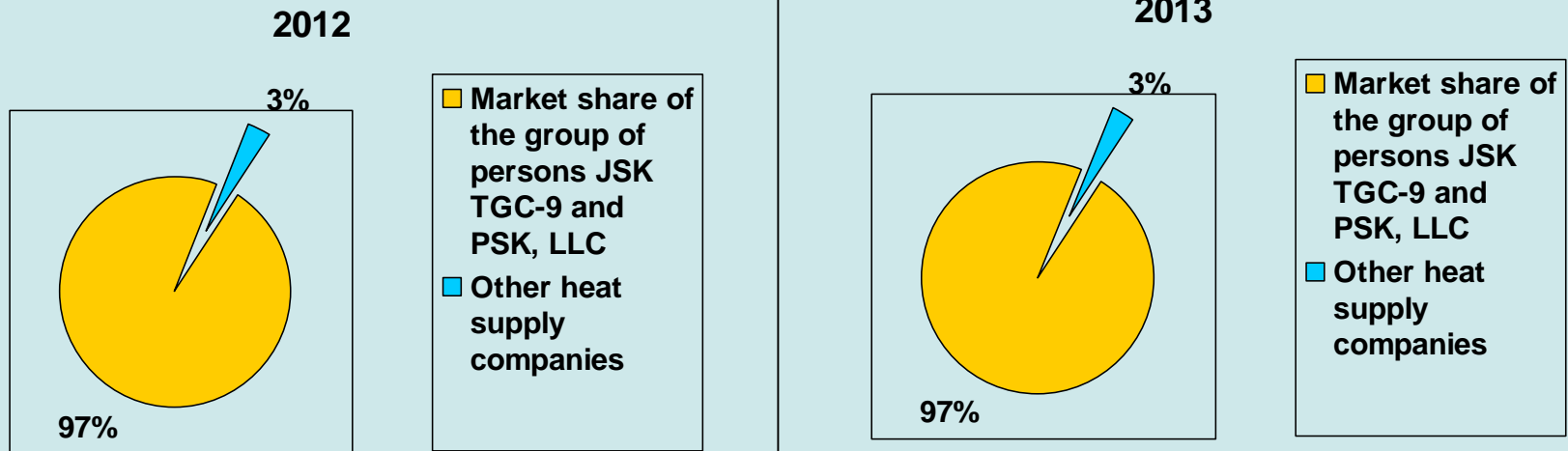

*By results of carrying out the analysis of a condition of the competition - Analytical report of the Perm OFAS Russia

Characteristic of the market of central heat supply of the central part of the city of Perm

- 1) Existence of formidable barriers: economic and administrative (to a lesser extent)
- 2) The commodity market is characterized by the undeveloped competition to what the highest coefficient of market concentration and steadily high Herfindahl-Hirschman index.
- 3) High concentration of the commodity market: the group of persons which includes PSK LLC and JSC TGC-9* has unconditional market influence.

By the part 1 article 9 of the Federal Law “On Protection of Competition” PSK LLC and JSC TGC-9 enter one group of persons on the basis of that the owner of 75 percent of a share in the stated capital of PSK LLC was JSC TGC-9, besides, JSC TGC-9 was the person having the right to act on behalf of PSK LLC without power of attorney (individual executive body)

Common graphic scheme of heat supply of end users of the central part city of Perm

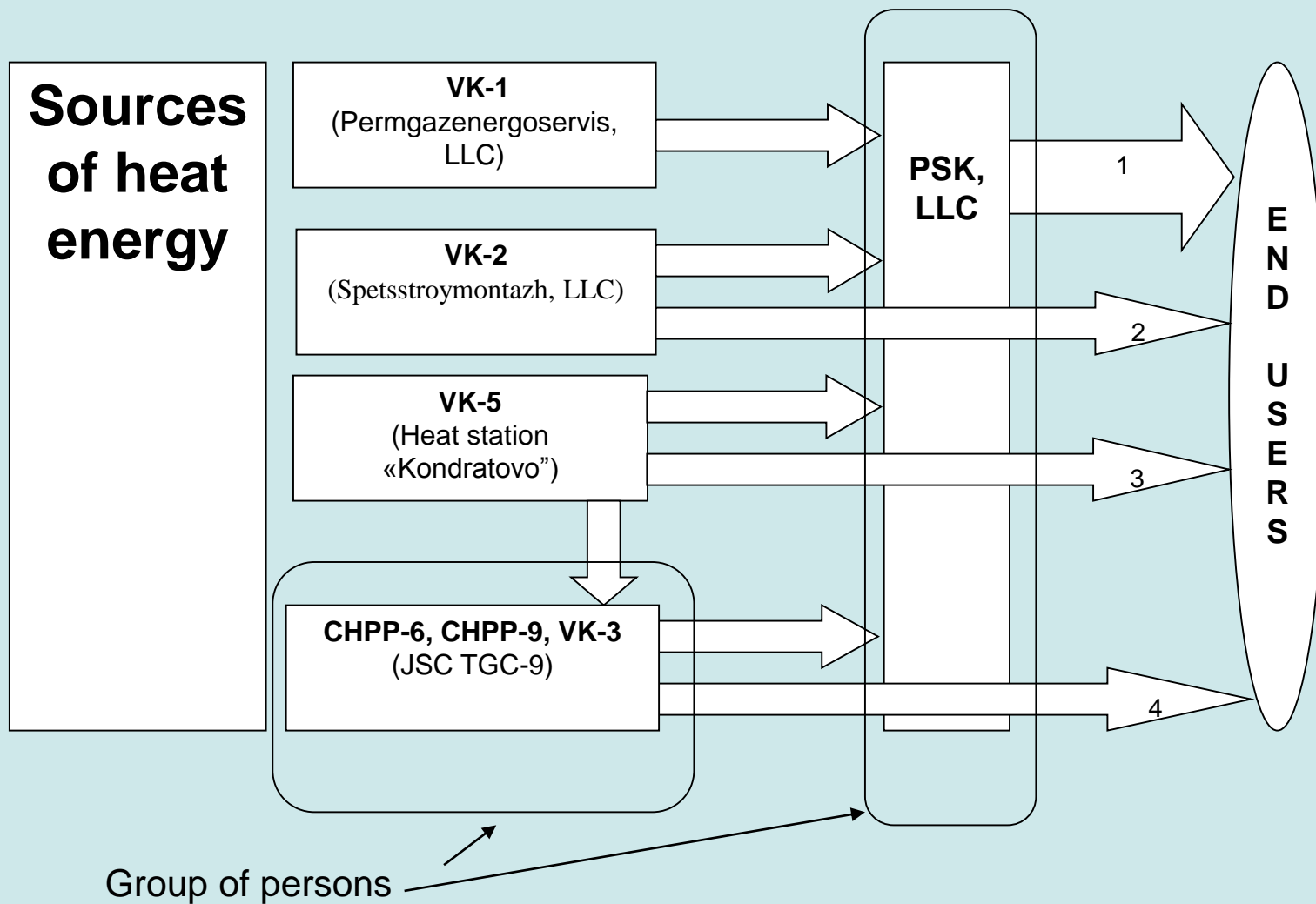

Features of the scheme of heat supply of end users

Not all organizations operating sources of thermal energy (heat generation) in borders of system of heat supply of the central part of the city of Perm having technological communications carry out supply of end users, and some of them distribute thermal energy between end users and other intermediary organizations.

Permgazenergoservice, LLC, VK-1 operating a source, all volume of the generated thermal energy delivers in favor of JSC PSK which also buys part of the generated energy from JSC Spetsstroyontazh (operates VK-2 source), at JSC Thermal Station Kondratovo (operates VK-5 source) and at JSC TGC-9 (operates sources of CHPP-6, CHPP-9, VK-3). At this JSC PSK isn't the generation company and doesn't operate sources of thermal energy.

Purposes pursued by a group of persons, which include JSC TGC-9 and PSK, LLC:

- 1) strengthening of position of a group of persons in the relevant commodity market.

Consequences of actions of a group of persons:

- 1) public character (negative influence on the competition)
- 2) private character (infringement of interests of the particular person)

Graphic scheme of heat supply of end users of the central part city of Perm
BEFORE abuse of a group of persons, which include JSK TGC-9 and PSK, LLC of a dominant position

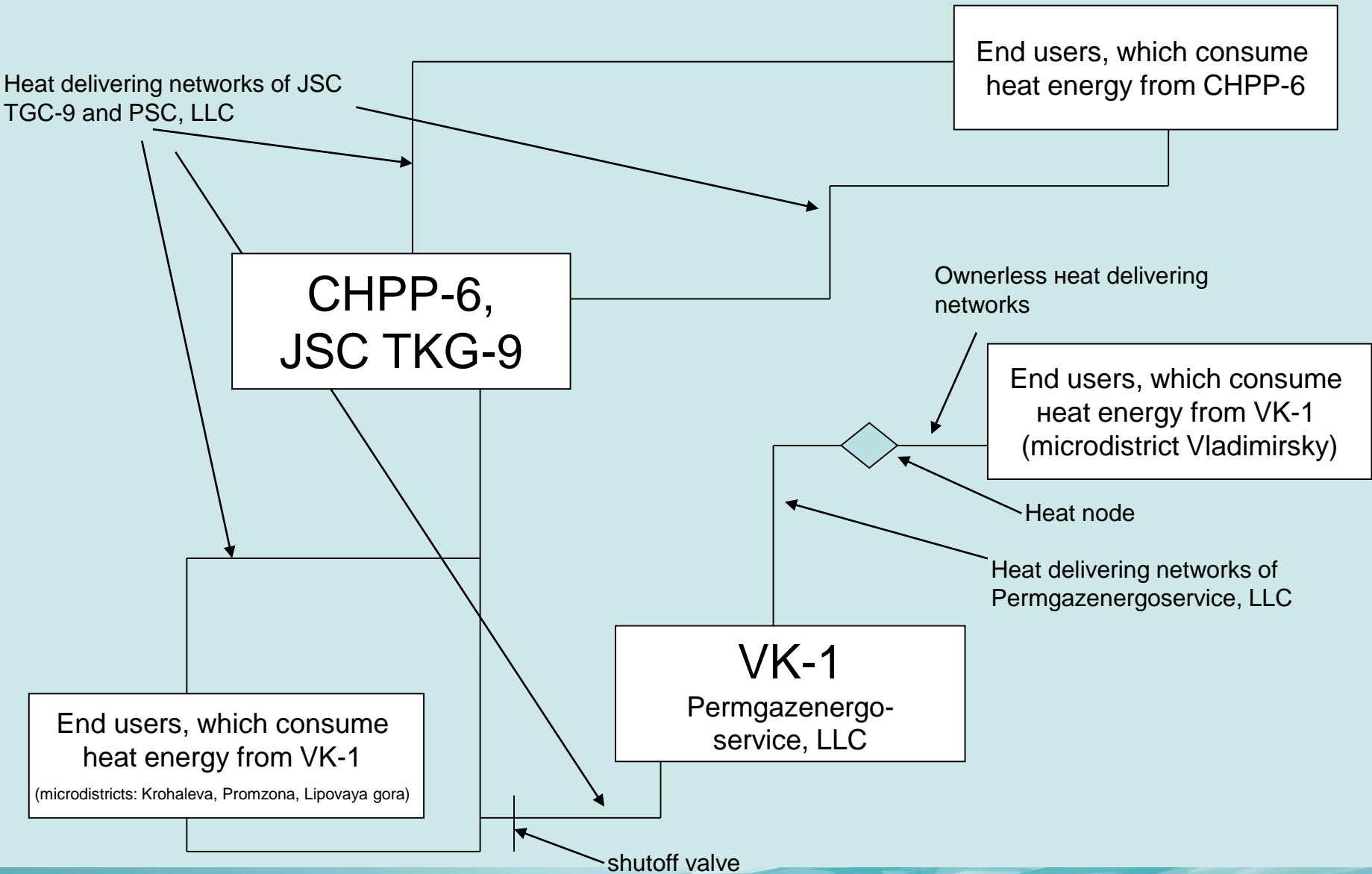

Graphic scheme of heat supply of end users of the central part city of Perm **AFTER** abuse of a group of persons, which include JSK TGC-9 and PSK, LLC of a dominant position

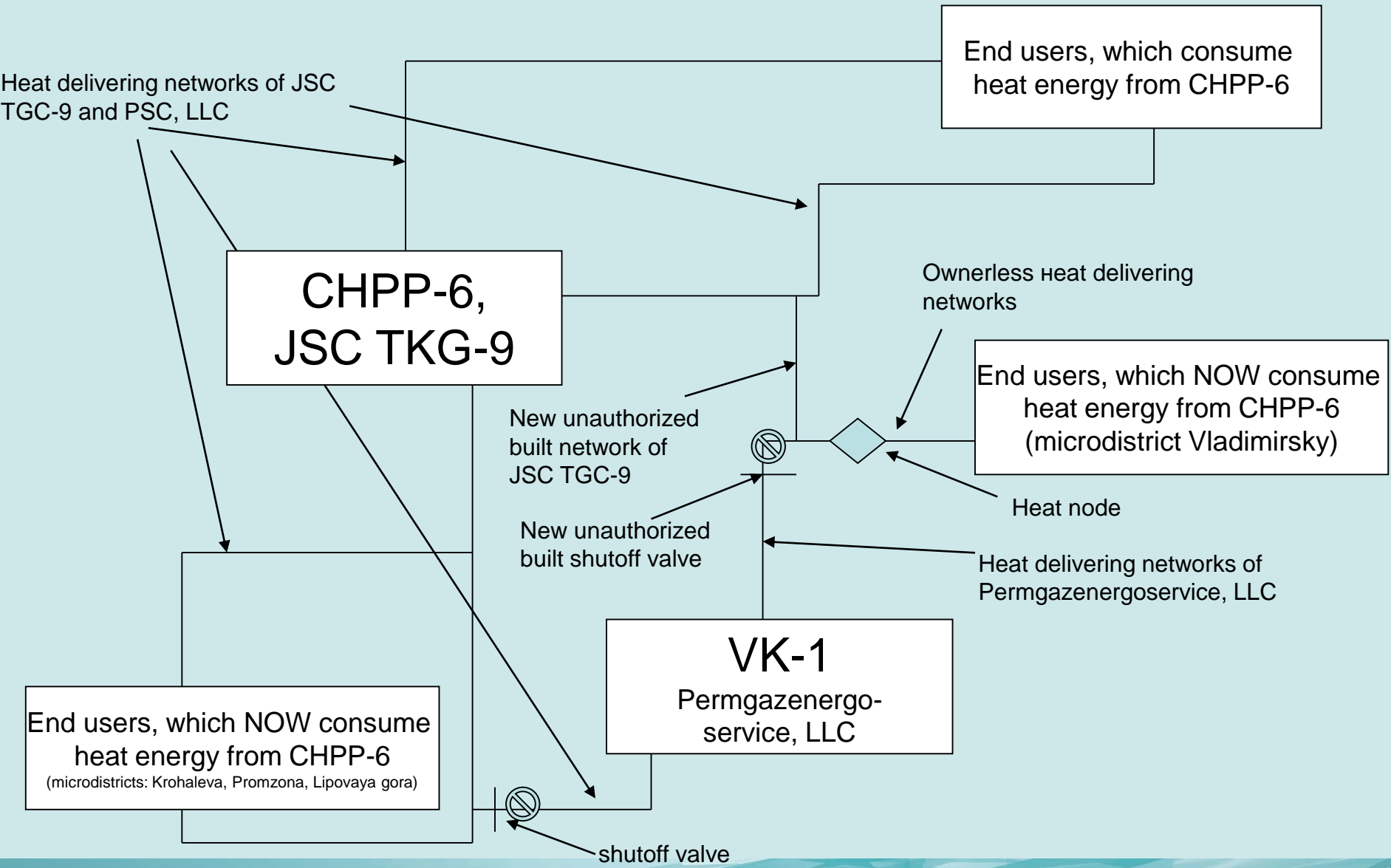

The Provision of Antimonopoly Legislation

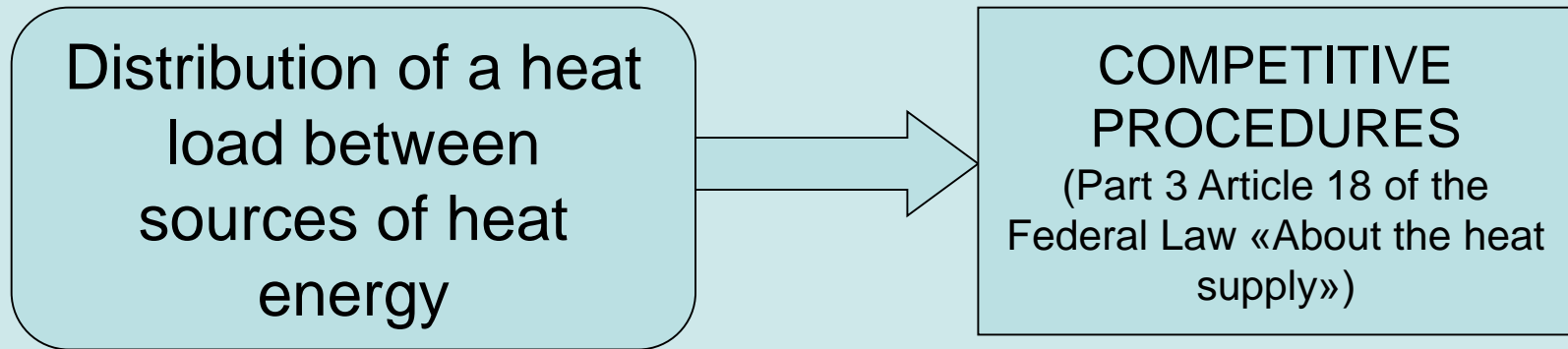

Change of the sources of thermal energy

According to the Federal Law of Russian Federation «About heat supply» the competition between heat supply sources is possible. The existing scheme of heat supply of the city of Perm is approved by the Ministry of Energy of the Russian Federation and regulates uniform rules of a choice of sources of thermal energy.

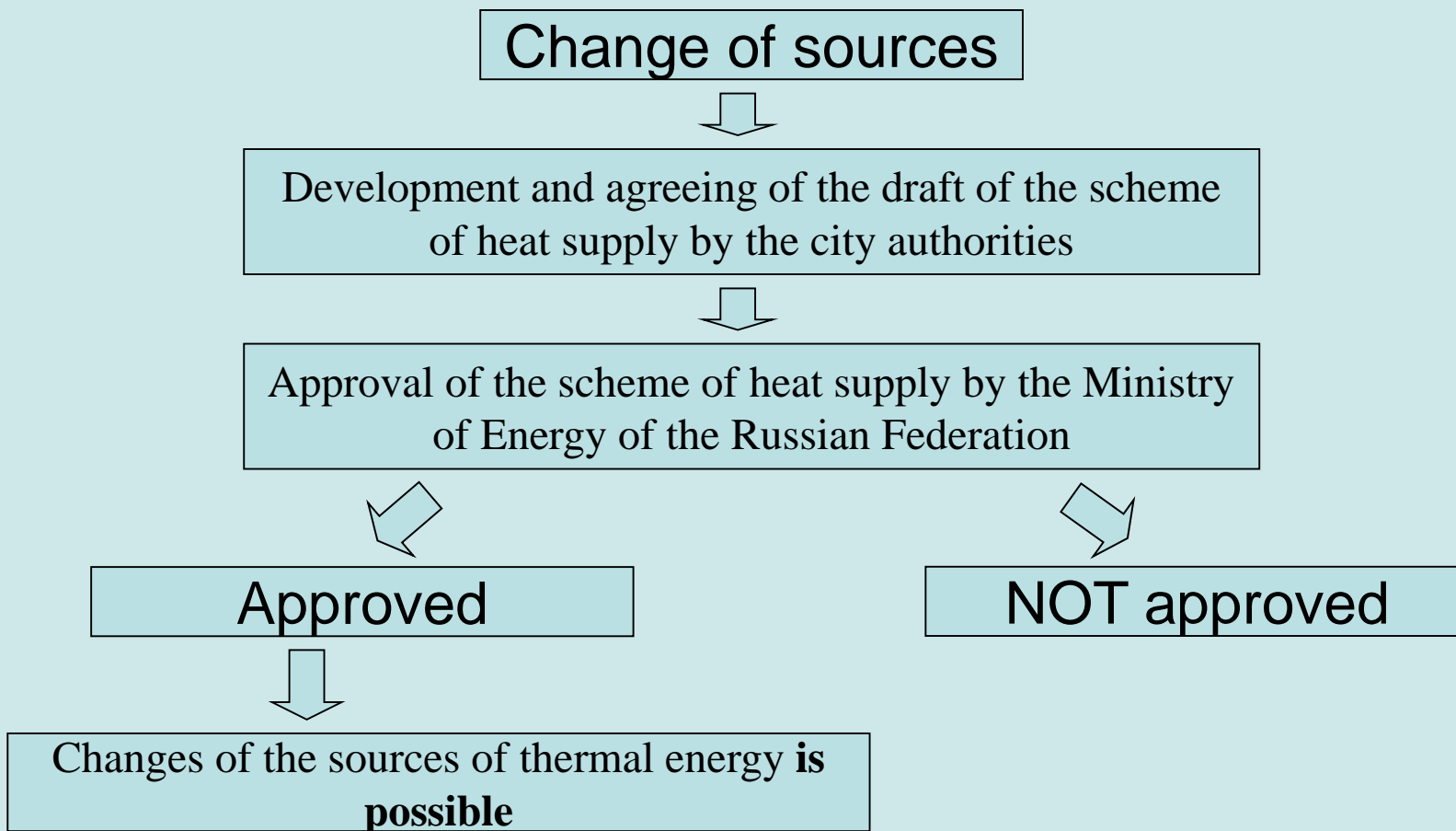

Description of violation of the antitrust law

The Commission of the Perm OFAS Russia found that group of person, which include PSK LLC and JSC TGC-9, violated Clause 1 Part 1 Article 10 of the Federal Law “On Protection of Competition” (abusing market dominance) by switching of a heat load of customers of heat energy in the microdistricts "Lipovaya gora", "Krokhaleva", "Vladimirskiy" and "Promzona" from boiler VK-1 on the Perm CHPP-6 with violation of the order set for such actions by article 18 of the Federal law "About the heat supply" that led to precluding of implementation of activities by Permgazenergoservice LLC and restriction of the competition.

The Commission of the Perm OFAS Russia issued mandatory determination to the group of person to stop abuse of a dominant position and to provide the competition

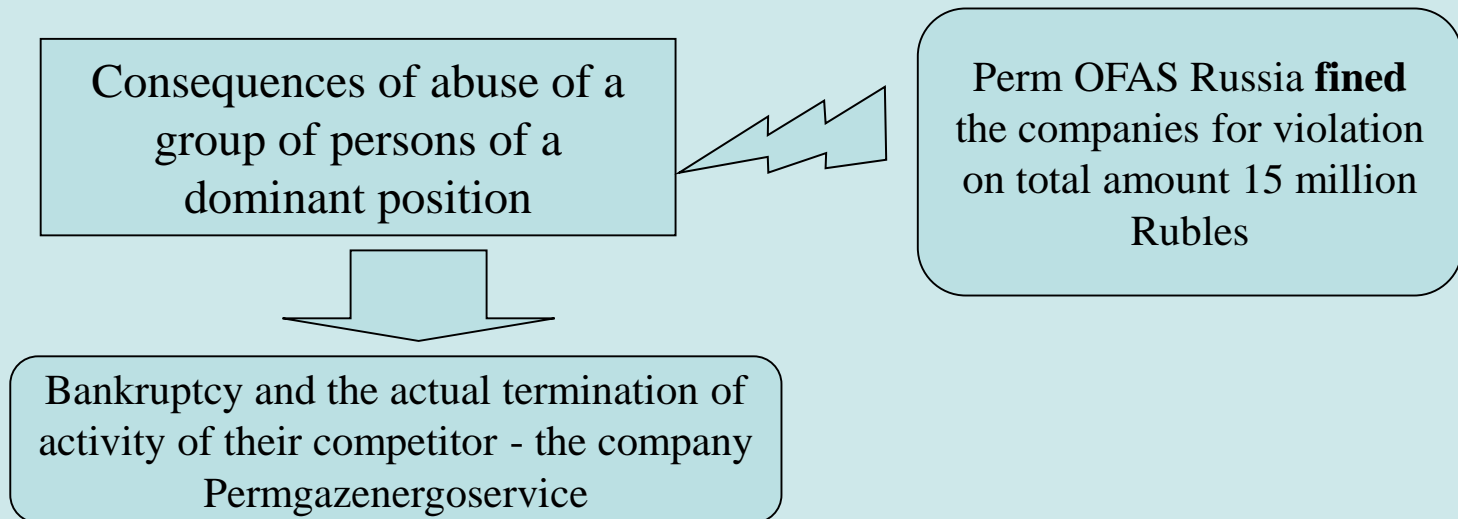



Thank for your attention!!

perm.fas.gov.ru

